



**BREWART®**  
BY COOPERS

**BREWFLO®**

TEMPERATURE CONTROLLED  
BEER DISPENSER



OPERATING MANUAL



# Welcome to the perfect pour!

Congratulations on the purchase of your BrewArt BrewFlo.

This manual covers the basic setup and operation of your BrewFlo. To discover the full BrewArt experience head to **BREWART.COM**



## Did you know?

**BREWART.COM/101** has lots of great how-to videos, FAQs and tips.

**⚠ WARNING:** Keep your BrewFlo upright in a cool, dry position out of direct sunlight and other heat sources. Designed for household use only.

**⚠ WARNING:** Keep plastic bag out of reach of children.

**NOTE:** When not in use turn off at the rear power switch.

# Contents

<b>Safety</b>	<b>4</b>	<b>Changing kegs</b>	<b>13</b>
<b>Customer Service</b>	<b>5</b>	Mid keg	13
BrewArt Customer Service	5	Empty keg	14
Product Specifications	5	<b>Cleaning</b>	<b>15</b>
<b>In the box</b>	<b>5</b>	<b>Power down</b>	<b>16</b>
<b>Getting to know your BrewArt BrewFlo</b>	<b>6</b>	<b>Condensation</b>	<b>16</b>
Control Panel with LCD Screen	8	<b>Troubleshooting</b>	<b>16</b>
<b>Getting started</b>	<b>9</b>	Re-setting the keg level indicator	16
Assembly	9	Error codes	17
<b>Operation</b>	<b>10</b>	<b>Warranty</b>	<b>18</b>
1. Inserting a keg	10	<b>Disposal</b>	<b>18</b>
2. Inserting the beer line	10	Correct Disposal of this product	18
3. Connecting the lines	11		
4. Powering up	11		
5. Pouring a beer	12		



# Safety

Your BrewArt BrewFlo has been designed and manufactured to the highest safety specifications and all relevant USA Standards (UL 250 Issued: 1993/11/01 Ed: 10 rev: 2013/02/22, CSA C22.2 No. 63 Issued: 1993/11/01 (R2013) Gen. Inst. 1 (1993) - 6 (2012)).

To ensure a safe, successful and rewarding experience please **read these instructions fully prior to use**, and if you have any queries, do not hesitate to contact BrewArt support on 855 522 2337 or at [customersupport@brewart.com](mailto:customersupport@brewart.com)

To prevent injury:

- › Read all instructions before use.
- › Remove packaging and safely discard packing material.
- › Only lift or transport your BrewFlo when it is empty. Always use safe lifting techniques.
- › Keep your BrewFlo upright in a cool, dry position away from direct sunlight and heat.
- › When not in use, keep machine turned off at the power point.
- › Keep all vents clear.
- › Do not disassemble your BrewFlo for any reason.
- › Only use genuine BrewArt accessories.
- › Only use your BrewFlo for dispensing BrewArt Kegs.
- › Keep your BrewFlo away from children and pets.
- › Do not store explosive substances such as aerosol cans with a flammable propellant in your BrewFlo.
- › If the power cord is damaged, it must be replaced by the manufacturer, its service agent or similarly qualified persons in order to avoid a hazard.
- › The BrewFlo is intended for household and domestic use only.
- › The BrewFlo is not intended for use by persons (including children) with reduced physical, sensory or mental capabilities, or lack of experience and knowledge, unless they are supervised or given instruction concerning the use of the BrewFlo by a person responsible for their safety.
- › Only use a soft damp cloth to wipe down external surfaces. Do not use solvents or harsh chemicals. A mild detergent may be used.
- › Failure to keep your BrewFlo upright may result in damage to its compressor cooling system.
- › **Do not use an extension cord.**

## WARNING

**The wires, electronic components and refrigerant in this product contain chemicals known to the State of California to cause cancer and birth defects or other reproductive harm. Wash hands after handling.**

## Customer Service

### BrewArt Customer Service

Phone: 855 522 2337

Email: [customersupport@brewart.com](mailto:customersupport@brewart.com)

[brewart.com](http://brewart.com)

BrewArt is a registered trademark of Coopers Brewery Ltd.  
ABN 13 007 871 409

**US Distributor**  
**Coopers DIY LLC**  
**Tucson AZ**  
**85716**  
**USA**

## Product Specifications

Model: BE641-US  
Class: I  
Capacity: 5.0L/1.3 gal.  
Voltage: AC110–120V  
Frequency: 60Hz  
Current: 2.0A  
Climate Type: SN/N/T/ST  
Refrigerant: R134a (1.77 OZ)  
Vesicant: Cyclopentane (C<sub>5</sub> H<sub>10</sub>)

## In the box

- › BrewArt BrewFlo
- › Drip tray
- › Beer font with interchangeable top, screws and plugs
- › Air elbow connector
- › Instruction manual

For the complete BrewArt System including the full range of BrewPrints and Accessories visit [brewart.com](http://brewart.com)

# Getting to know your BrewArt BrewFlo

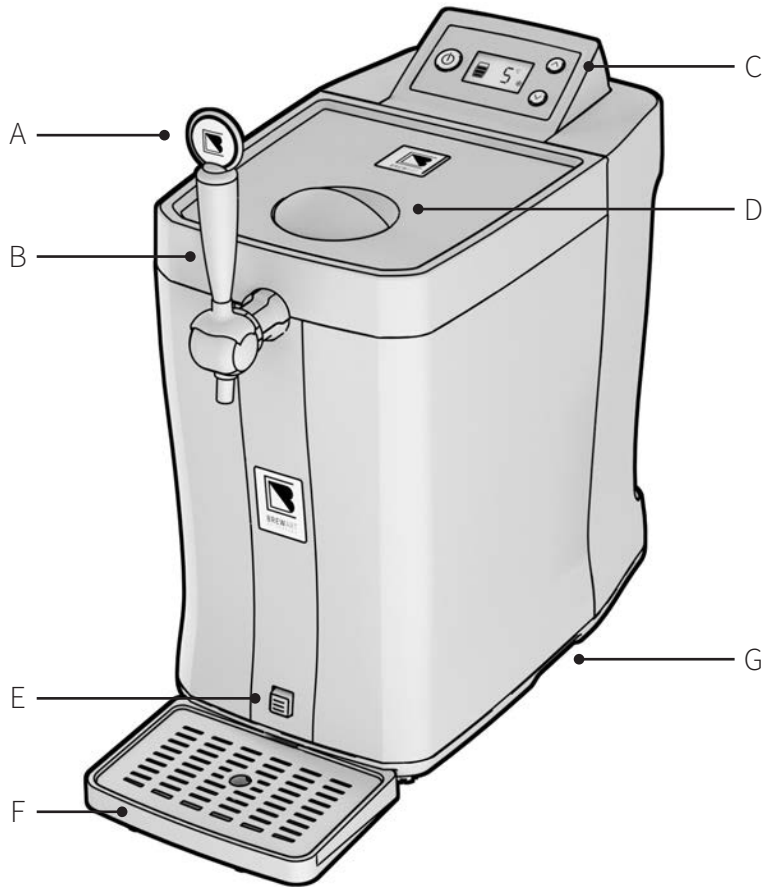

## Did you know?

[Brewart.com/101](http://Brewart.com/101) has lots of great how-to videos, FAQs and tips.

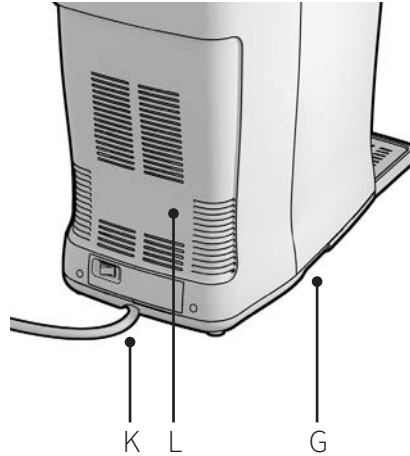
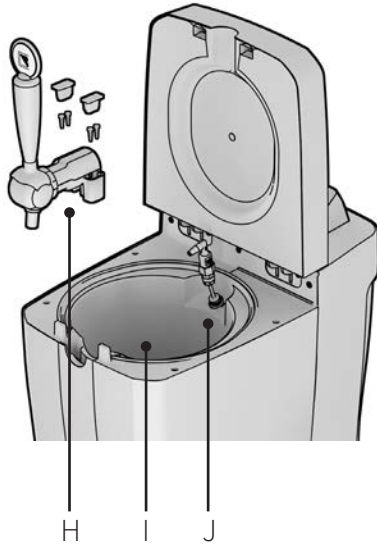

- A. Interchangeable Font Top:**  
Insert your own label for each brew
- B. Beer Font:**  
To dispense beer
- C. Control panel with LCD screen:**  
Control temperature and track keg volume (see page 8)
- D. Lid release handle:**  
Quick access to the keg chamber  
**⚠ Not for lifting your BrewFlo**
- E. Drain plug:**  
Releases condensation build-up from inside cooling chamber
- F. Drip tray:**  
Catches drips from Beer Font
- G. Carry handles:**  
Safe, easy moving and handling

- H. Beer font screws (x4) and plugs (x2):**  
Holds your beer font securely in place
- I. Internal cooling chamber:**  
Keeps your Keg at the set temperature
- J. Air line with elbow connector:**  
Pressurizes the keg to dispense beer
- K. Power cord**
- L. Vents:**  
Keeps your BrewFlo compressor cool. Do not block!

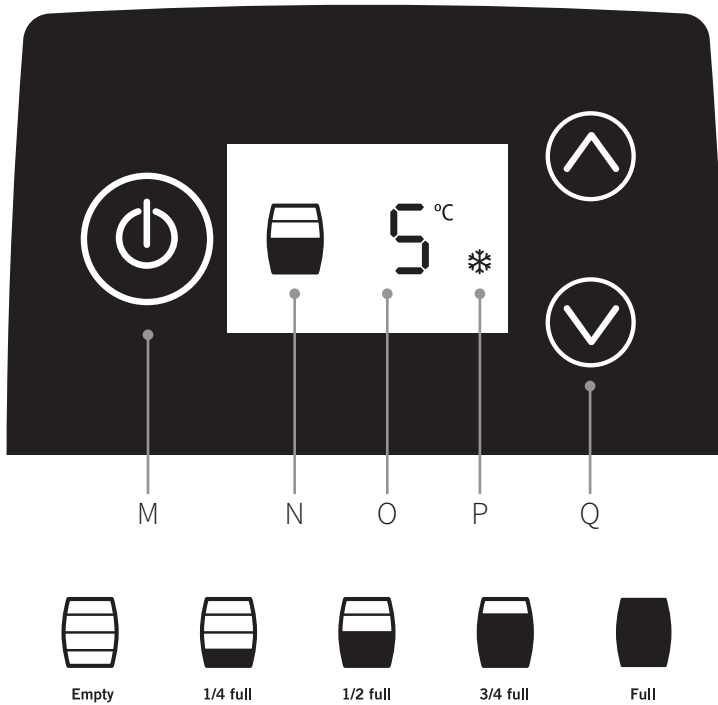

## Control Panel with LCD Screen

### M. On/Standby button:

Switches your BrewFlo between **ON** and **STANDBY** mode

### N. Beer level indicator:

Estimates the volume of beer remaining in the keg, to the nearest quarter

### O. Target temperature:

Your Keg will be maintained at this temperature

### P. Cooling indicator:

Indicates the BrewFlo is cooling

### Q. Temperature set buttons:

- › Use these buttons to set the Keg target temperature.
- › To switch the temperature display units between Celsius °C and Fahrenheit °F, press and hold the Up-Arrow button for 3 seconds, the unit will beep and the temperature display units will change.
- › In standby mode, these buttons can be used to reset the Beer Level Indicator – see **Troubleshooting section**.



# Getting started

- › Record your warranty online by visiting [brewart.com/register](http://brewart.com/register)
- › BrewArt BeerDroid and BrewFlo come with a 12 month Limited Replacement Warranty.
- › We recommend that you register your hardware items for warranty.
- › To view full Terms and Conditions of Sale, including Limited Replacement Warranty details go to [brewart.com/warranty](http://brewart.com/warranty)
- › Position your BrewFlo on a clean flat surface in a dry area away from direct sunlight or other heat sources.
- › Ensure all vents are free of obstructions and your BrewFlo is at least 10cm away from walls and other objects – see **Diagram A**.

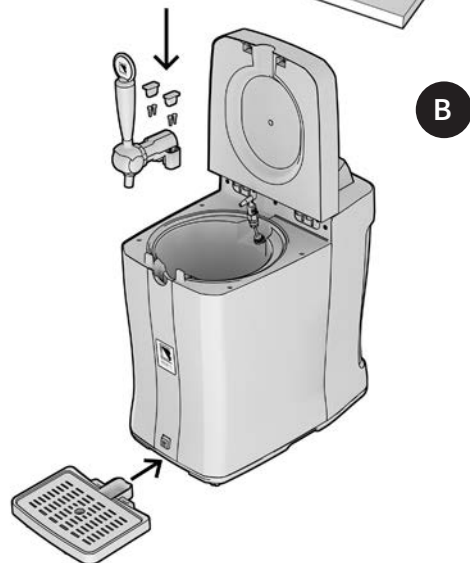
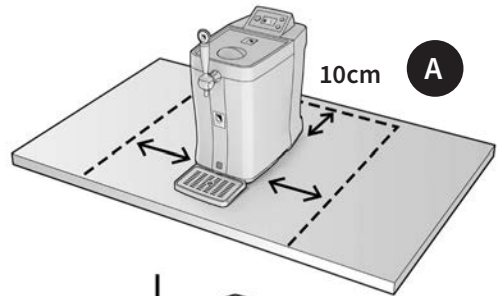

## Assembly

### **⚠ WARNING**

**DO NOT** tilt or lay BrewFlo on its back or side as this can cause damage to the compressor.

- › Open your BrewFlo lid
- › Fit the beer font into your BrewFlo and, using the screws, secure it in place – see **Diagram B**.

### **i Note**

Use a magnetic screwdriver to make inserting screws easier.

- › Insert plugs into the recesses to either side of the front.
- › Insert the drip tray by sliding it into the base of your BrewFlo.

### **⚠ WARNING**

Do not move your BrewArt BrewFlo during operation.

**i Note**

Use only BrewArt 5 Litre kegs. Your BrewFlo will chill a warm keg in approximately 10 hours so for immediate use we suggest you pre-chill your kegs in your refrigerator.

**C**

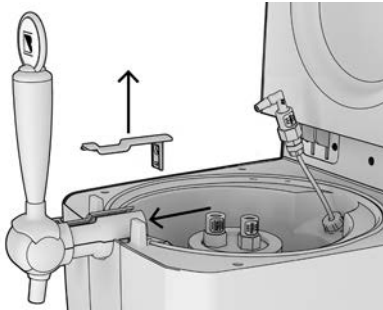

**D**

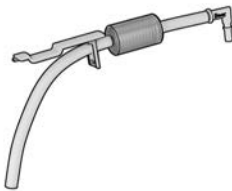

**E**

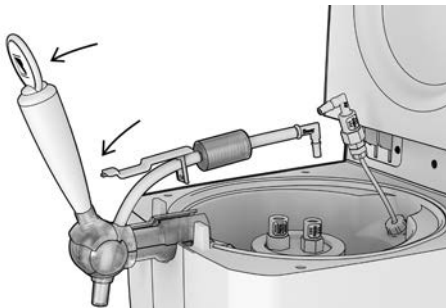

# Operation

## 1. Inserting a keg

- › Only use BrewArt kegs that have fully completed their secondary fermentation. If unsure, visit [brewart.com/101](http://brewart.com/101)
- › Open the lid and insert a BrewArt keg.

## 2. Inserting the beer line

- › Release the beer line holder from the font by pressing the release button at the base of the font connection – see **Diagram C**.
- › Unclip the beer line holder and feed the open end of the beer line all of the way through the hole – see **Diagram D**.
- › Pull the font handle forward, and then feed the open end of the beer line into the font until it stops (approximately 3cm) – see **Diagram E**.
- › Release the font handle.
- › Fit the beer line and beer line holder back into place.

**i Note**

The beer line must be installed in the Font before connecting it to a Keg.

### 3. Connecting the lines

- › Connect the beer line to the keg by inserting its connector to the orange keg valve. Press the connector until it clicks into place, ensure beer line is straight and free of kinks – see **Diagram F**.
- › Connect the air line to the keg by inserting the connector to the black keg valve. Press the connector until it clicks into place – see **Diagram G**.
- › Close the lid.

#### **i** Note

It is best to wait until your keg is chilled before connecting air and beer lines.

F

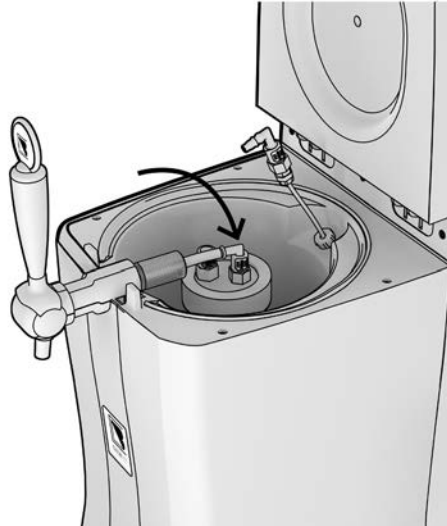

### 4. Powering up

- › Plug the power cord found at the rear of your BrewFlo into a power point and turn on at the power point.
- › Set power switch at the back of your BrewFlo to **ON**.
- › The display screen will light up and momentarily display all LCD screen content, the current software version will display, and then it will enter standby mode.
- › On the control panel press the **⏻** button to turn **ON**.

G

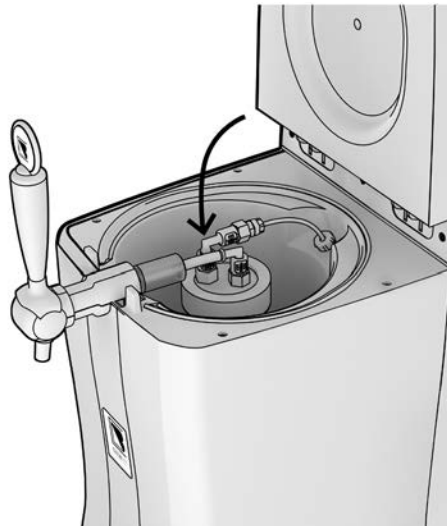

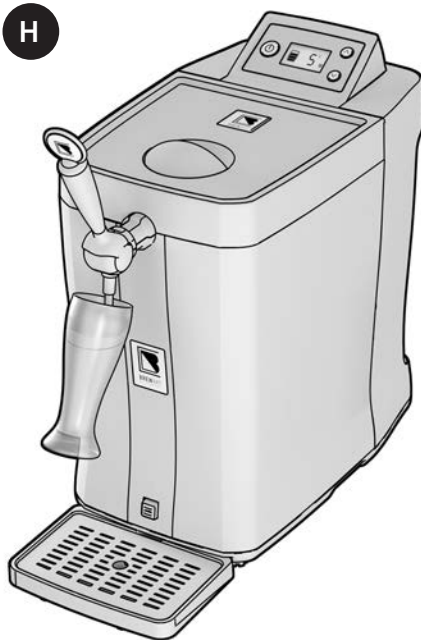



## 5. Pouring a beer

- › When the beer is ready to pour, place a clean glass on a slight angle underneath the beer font tap – see **Diagram H** – and pull the font handle all the way towards you in one smooth action. Refer to **brewart.com/101**
- › When a keg is first inserted there will be additional foam in your first pour. We recommend discarding the first half a glass you pour.
- › As it fills, straighten the glass slowly until it is fully upright.
- › When the beer head reaches the rim of the glass, quickly release the font handle to return it to the off position.

### **i** Note

If your BrewFlo loses power while in **ON** mode, it will automatically return to **ON** mode when power is restored.

- › The beer level indicator should display the approximate beer level in the keg.
- › The target temperature is displayed.
- › Use the  and  arrows to change the target temperature
- › The BrewFlo will adjust the temperature accordingly. The  icon will appear on the display screen to indicate the BrewFlo is cooling.

### **i** Note

Do not immerse the font nozzle into the beer or foam while pouring.

- › The Beer Level Indicator on the LCD screen will indicate how much beer is left in the keg. For shelf-life and expiry of kegs, see **brewart.com/101**

### Hint

The size of the head can be controlled by adjusting the angle and position of the glass.

# Changing kegs

## Mid keg

### **i Note**

You can remove a partially used keg and replace it with another keg at any time.

- › Disconnect the air line by pressing the white release button on the airline keg valve. The black elbow connector should release – see **Diagram I**.
- › Disconnect the beer line by pressing the orange release button on the Beer keg valve. The connector should release.

### **i Note**

Place a cloth or paper towel around the beer valve to catch the small beer squirt when disconnecting from the keg beer valve.

- › Release the beer line holder by pressing the button and unclip it from the beer font.
- › Raise the beer line and pull the font handle forward to drain any residual beer from the beer line – see **Diagram J**.

- › Pull the beer font handle forward and pull the beer line out from the beer font.
- › Remove keg.
- › Rinse any beer in the keg beer valve with clean water.
- › Replace keg. Refer to **Inserting a keg**.

**I**

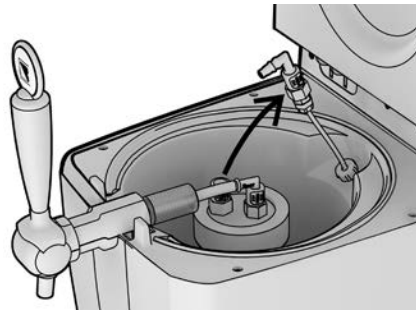

**J**

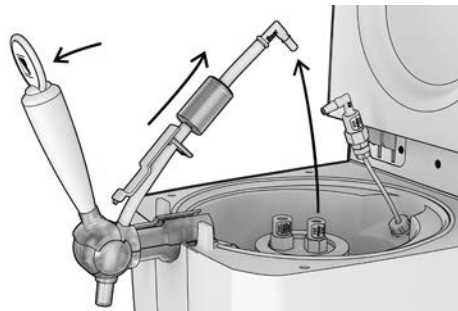

**i Note**

It is important to keep a partially used keg pressurized to maintain carbonation levels in your beer. If you accidentally depressurize the keg simply use the BrewFlo to pressurize it again.

**K**

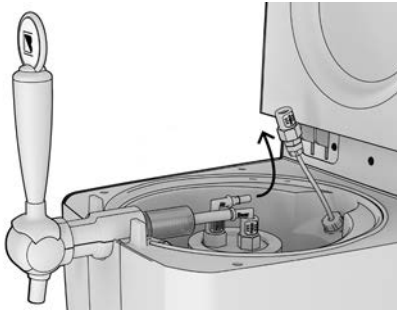

**L**

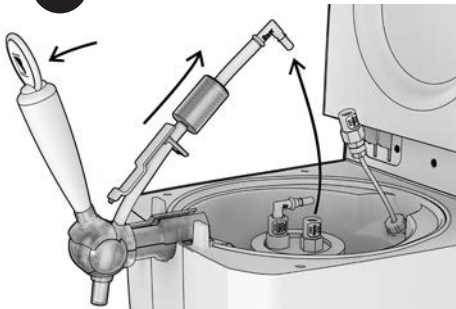

## Empty keg

- › To depressurize the keg, leave the air line connector in the keg. Release the air line by pressing the white release button, and pulling the airline away from the black connector – see **Diagram K**.
- › Wait for air to completely expel from the keg.
- › Return the elbow connector to the air line.
- › Disconnect the beer line by pressing the orange release button on the Beer Line keg valve. The connector should release from the keg.
- › Release the beer line holder by pressing the button and unclip it from the beer font.
- › Raise the beer line and pull the font handle forward to drain any residual beer from the beer line – see **Diagram L**.
- › Pull the beer font handle forward and pull the beer line out from the beer font and beer line holder and safely dispose beer line.
- › Remove keg.
- › Unscrew the keg cap and remove foil keg liner.
- › Safely dispose of the foil keg liner and beer line.
- › Clean and rinse the Cap assembly with clean water and allow to air dry taking care not to lose small parts when disassembling the valves.

**i Note**

Remember to sanitize your keg cap before each use.

**i Note**

The same beer line can be used with the new keg.

Once a beer line is used we recommend that it be disposed of and replaced with a new beer line within three days of initial use if not kept cool within the BrewFlo or seven days if is kept cool.

For more FAQs and information on beer lines and storing partially used kegs, please go to [brewart.com/101](http://brewart.com/101)

## Cleaning

Clean your BrewFlo with a clean soft damp cloth, do not use solvents or abrasive agents, if necessary you may use a mild detergent.

**i Note**

Cleaning up spills and splashes as soon as they occur helps keep your BrewFlo looking it's best.

During use, empty and rinse the drip tray regularly.

When finished using the BrewFlo:

- › Power off the unit at the rear switch.
- › Remove the Keg and Beer Line.
- › Rinse the inside of the beer font spout with clean water.
- › Drain any condensation and spills from the inside of the unit by pressing the drain button.
- › Wipe the inside of the BeerFlo with a soft clean damp cloth.
- › Empty the drip tray and rinse it with clean water.
- › Wipe the outside of the unit with a soft clean damp cloth.
- › Keep empty Kegs clean and dry and rinse and clean the Cap assembly with clean water and allow to air dry after Keg is empty.



## Power down

- › Turn your BrewFlo to standby using the  button on the control panel, or if you are not going to use it for an extended period turn it off completely at the power switch at the rear of your BrewFlo.

## Condensation

- › After extended use, the cooling chamber may fill with condensation. If this happens, press the drain button at the front of your BrewFlo until all the condensed water drains into the tray. Any remaining condensation in the chamber can be removed by wiping it with a clean soft cloth.
- › In humid locations condensation may appear on the bench underneath the BrewFlo. Wipe any condensation from the bench with a soft cloth.



### **WARNING**

DO NOT tilt or lay your BrewFlo on its back or side as this may damage the compressor.

## Troubleshooting

Beer pouring flat or heady? for these and many other troubleshooting tips, FAQs and instructional videos, please visit [brewart.com/101](http://brewart.com/101)

### Re-setting the keg level indicator



1. If you notice that the keg gauge is not displaying the correct keg levels, you may need to re-set the load monitor.
2. Plug the power cord in and switch your BrewArt BrewFlo on.
3. Use the  button to set your BrewFlo to standby mode (Power is on but LCD is off).
4. Place an empty keg plus the cap and collar in your BrewFlo (no need to connect air and beer lines).
5. Hold  and  arrows simultaneously for approximately 3 seconds, until your BrewFlo beeps.
6. The load monitor will be re-set to empty, taking into account the weight of the empty keg and cap.

### **Note**

You don't need to place a keg liner in your BrewFlo as its weight is negligible.



## Error codes

Code	Description	User Action
E1	<p>Load cell error.</p> <p>The load cell determines the weight of the keg and therefore the volume of beer remaining.</p>	<p>Power off the unit at the wall for one minute and try again, if the problem persists please visit <a href="http://brewart.com/101">brewart.com/101</a> where you will find FAQs and trouble shooting information. If this does not help resolve your issue, please contact customer service.</p>
E2	<p>Temperature sensor error.</p>	<p>Power off the unit at the wall for one minute and try again, if the problem persists please visit <a href="http://brewart.com/101">brewart.com/101</a> where you will find FAQs and trouble shooting information. If this does not help resolve your issue, please contact customer service.</p>
E3	<p>Air leak.</p> <p>Keg failed to pressurize within 10 minutes time limit.</p>	<p>Check the following:</p> <ul style="list-style-type: none"> <li>➤ Connectors clicked together properly</li> <li>➤ Keg collar is securely screwed down</li> </ul> <p>Please visit <a href="http://brewart.com/101">brewart.com/101</a> where you will find FAQs and trouble shooting information. If this does not help resolve your issue, please contact customer service.</p>
E4	<p>Pump overload.</p> <p>An Air Pump overload has been detected, the air pump has been stopped for safety.</p>	<p>To reset this error press the front panel  button to put the unit in standby, clear error and reset unit. After a few seconds press  again. If the problem persists, please visit <a href="http://brewart.com/101">brewart.com/101</a> where you will find FAQs and trouble shooting information. If this does not help resolve your issue, please contact customer service.</p>



## Warranty

BrewArt BeerDroid and BrewFlo come with a 12 month Limited Replacement Warranty.

We recommend that you register your hardware items for warranty.

To view full Terms and Conditions of Sale, including Limited Replacement Warranty details go to [brewart.com/warranty](http://brewart.com/warranty)

## Disposal

### Correct Disposal of this product



- › This marking indicates that this product should not be disposed of with other household waste.
- › To prevent harm to the environment or human health from uncontrolled waste disposal, please recycle this product responsibly.
- › Please contact your local municipal authority or the retailer you purchased the product from for advice on your closest collection depot that can recycle this product in an environmentally responsible and sustainable manner.

# Notes

© Coopers 2016 / US – V1

BrewArt, BeerDroid and  
BrewFlo are registered  
trademarks of Coopers.

Due to continued product  
improvement, the products  
illustrated/photographed in  
this brochure may vary slightly  
from the actual product.

Updates to this manual  
may be found at  
**brewart.com**